

An **Evolution** in Laser and UV phototherapy

Next generation portable and digital phototherapy for the way you live.

Dermaray takes the guess work out
of home phototherapy.



Dermaray®

Intelligence in Phototherapy

User Instruction Manual

Dermaray® UV Lamp

Model NB-311

Version 1.01 (Rev 0.998) 2010



*Portable Ultraviolet Light Therapy for treatment of
Psoriasis, Vitiligo, Dermatitis
and other skin conditions*

Read All Instructions Thoroughly Prior To Activating the Device

Document version number:	0.998
Date of publication:	30-Mar-11
Copyright:	Total Control Pty. Ltd. 2009
Updates available from:	www.dermaray.com
Your Serial number:	_____
Software version number:	_____
Date of purchase:	_____
Place of purchase:	_____
Purchase invoice number:	_____

www.dermaray.com

Table of Contents

Table of Contents	2
Introduction	4
Welcome and preface.....	4
Environmental notice	5
How to use these instructions	6
Dermaray UV - 101 Guide	6
Safety Information	7
Safety First.....	7
Safety precautions	7
Device compliance	9
When not to use - UV lamp Therapy	10
Hazards when using Dermaray - UV lamp	10
Proper usage	10
Your UV lamp Pack inclusions	11
Spare Parts – Bulb Replacement	12
Getting started	13
Main components of You UV lamp Comb	14
Proximity Detector Explained	15
Battery charging battery care	16
Battery Charging Indicator Lights	17
General Operations	18
Setup and configuration.....	18
Establishing a treatment program.....	19
Using the UV lamp.....	19
Waking your UV lamp: The WAKE command.....	19
To turn off and enter sleep mode	20
Dermaray UV lamp: Setup Wizard	21
Setup Wizard: Flow Chart.....	22
Setup Wizard: Date (year, month, day)	23
Setup Wizard: Input Patient Name	25
Setup Wizard: Skin Type	26
Setup Wizard: Disease Type	27
Setup Wizard: Treatment Area's	28
Setup Wizard: Completed.....	29

What to do if the Wizard is not presented	29
Subsequent Activations: Welcome screen	29
Entering Manual Mode	30
Manual Activation – UP button	31
Manual Activation - Down button.....	33
Manual Activation next treatment – RIGHT button.....	35
Accessing HELP system – LEFT button	36
Entering Programming Mode.....	36
Main Menu and its four options;	37
Main Menu: 1. Treatment Summary.....	38
Main Menu: 2. Start Treatment.....	39
Main Menu: 3. Treatment Configuration.....	41
Main Menu: 4. System Tools.....	42
System Tools - Menu functions	42
Automatic Safety features	44
Protection against Over Exposure or Over Usage	44
Over Exposure Protection (duration).....	45
General Use and Operation	46
Online Help.....	47
Doctor and Specialist PC Connectivity	48
Bulb replacement guide.....	49
Bulb Life Time and Power Output	50
Battery pack replacement guide	51
Performing a software upgrade	53
Performing a Reset function	54
Software reset	54
Hardware reset	54
Trouble Shooting Tips	55
“IR Disconnection” error during treatments.	55
Dermaray UV lamp turns on, but won't start.	55
Specifications	56
Menu Structure Flow Chart.....	57
Warranty Information – Dermaray UV lamp	58
Warranty Registration Form	59

Introduction

Welcome and preface

Thank you for choosing a Dermaray phototherapy device. The Dermaray® - UV Lamp represents the world's leading, most technological advanced, and, safest hand held UV Lamp system available today.

Clinical trials conducted over several years have proven that Narrow Band Ultraviolet Light is effective in treating skin conditions such as Psoriasis, Vitiligo, Dermatitis Acne, and a host of other skin diseases. A trial undertaken in 2007 confirmed that Ultraviolet B phototherapy administered at home is equally safe and cost effective, both clinically, and for quality of life, to that of ultraviolet B phototherapy administered at an outpatient setting.

Designed and Manufactured by Total control Pty. Ltd to ISO 13485 International Quality Control Standards, Your **Dermaray® UV Lamp is a premium quality and “Best of Breed”, medical device** that will deliver an optimum amount of UV therapy, to maximize the effectiveness of your treatment as advised or prescribed by your medical Specialist.

Your Dermaray® UV Lamp has numerous Intelligent and superior built-in features and safeguards, that no other phototherapy device can provide;

It includes; an on-board **computer**, which will create your individual treatment plan, then, Monitor, Regulate, Control, Prompt, Record and Log, your usage.

The **proximity detector**/sensors assist the user by alerting you of incorrect operation, and will automatically turn the device off if it senses no activity, eliminating over- exposure, and possible eye damage.

The ultra long life **re-chargeable** batteries ensures continuous and safe treatment sessions, without being directly connected to mains power, which can impede the users safety, as well as pose a danger; and the **Universal Power Supply** means that you can use your device anywhere in the world, (you will need only acquire the correct power cord for the country of destination)

The Dermaray® UV is the easiest, smartest, safest, and most cost effective system available. It can be used in Manual Mode or in Advanced Mode under the watchful eye of you medical practitioner or therapist with use of the Dermaray® computer controlled PC Software package.

Dermaray is about simplifying Phototherapy and eliminating Phototherapy guess-work, together with providing a unique level of safety and automation which no other UV lamp can provide. Remember if ever in doubt as to whether Phototherapy or UV treatments are for you, we highly recommend seeking the advice of a qualified medical consultant in the first instant.

Thank you, and Congratulations on your purchase of the Dermaray UV Lamp, we wish you the greatest success with your treatment, and hope you achieve your goal.

Environmental notice

In the interest of taking care of our environment Dermaray will use recycled packaging and printing materials where possible. Appropriate environmental manufacture and waste disposal regulations are followed. Dermaray has been manufactured to all appropriate environmental standards. Including RoHS reduction of hazardous substances (including lead free)

How to use these instructions

Dermaray UV - 101 Guide

This user's Instruction Manual should be read completely from start to finish PRIOR to following any specific instructions or attempting to use or charge the Dermaray UV lamp batteries for the first time. Once read, you should follow all instructions and then also refer to these instructions while configuring your Dermaray UV lamp for the first time. The suggested process is as follows;

- Read these instructions fully from front to back
- Charge batteries fully as described in these instructions
- Read Safety Instructions
- Configure Dermaray UV Lamp for initial use
- Refer to this guide as required
- Contact your supplier for assistance if required
- Contact Dermaray technical support if required

Safety Information

Safety First

Dermaray[®] - UV is a powerful hand held Ultra Violet (UV) lamp, it is a Class IIa ionizing radiation emission device. It must only be used in accordance to this user's guide titled "Dermaray[®] - UV User's Instruction Manual." Incorrect usage of this device may be dangerous to your health, and void your Warranty Status. User Manuals are replaced from time to time so please download the latest copy from;

www.dermaray.com/forms/dermaray-uv-manual.pdf

Safety precautions

Sunburn from over exposure should be avoided with phototherapy. Similarly avoid excessive direct natural sunlight before, after and between phototherapy treatments. If after treatment your skin appears red or pink, feels excessively itchy, hot or prickly discontinue use until your skin has fully recovered. If symptoms persist, please see your health care professional. If burning results shorten the next several treatments and consider extra recovery time between treatments. Phototherapy programs are a suggestion and should be used as a guide only.

NOTE: Burning as a result of overexposure or excessive and too frequent exposures may not be immediately noticeable and may take 12-24 hours to become apparent. Never repeat treatment more than once in a 24 hour period unless under direct medical supervision. Other precautions include;

- Please follow these instructions carefully to minimize health risks and damage to property.
- Dermaray[®] - UV emits intense UV radiation which can be dangerous if overdosed resulting in sunburn/skin burns, conjunctivitis, keratitis (retina damage,) aging of the skin and skin cancer.
- Never operate without UV safety goggles. You must wear the safety goggles at all times. When possible, also keep your eyes closed, particularly if treating the scalp or face.
- Any person in the vicinity of the device must also wear safety goggles, particularly if assisting the patient.
- Never look directly into the light with your eyes open (even with goggles.) If treating your face, keep eyes closed and goggles on at all times.
- Perform irradiation only as described in the operating instructions or as recommended by a doctor.
- Never use the appliance in the bath tub or other wet areas.
- Never use a damaged product or damaged power supply.
- Ultra Violet radiation from sunlight and other sources has been proven to cause aging of the skin and skin cancers, however there is no proven link between measured medical dose phototherapy and skin cancer. UV phototherapy should be considered a potential carcinogen.

- Do not perform UV phototherapy after photosensitizing of the skin by cosmetics, foods or medicine etc.
- Do not use UV phototherapy concurrently or within several months of radiation therapy unless instructed by your doctor.
- Cover parts of your body that you do not want to treat.
- Use a high protection sunscreen on areas not requiring treatment, apply this at least 20 minutes before treatment.
- Consider wearing a protective glove on the hand holding the device to protect your hands from frequent unnecessary exposure.
- The side effects of excessively long time treatment or over exposure are, burning similar to sunburn, erythema, blisters and erosions, pigmentation and itching
- Eye lids and the male testicles cannot receive UV phototherapy under any circumstances – the skin is too thin and damage will occur.
- Use only the approved safety goggles supplied – sunglasses or other generic goggles may not provide adequate protection.
- Home phototherapy should ideally be supervised by an appropriate medical practitioner.
- Use only in accordance with local government regulations and safety protocols.
- Only use the device in areas of temperature below 40c and in low humidity environments.
- Store in a cool, dry place away from heat and direct sunlight.
- Avoid charging Dermalay when it is warm or hot.
- Never use Dermalay® - UV while connected to mains power, use only on battery operation.

NOTE: Never repeat a treatment session within a 24 hour period unless instructed to by your medical practitioner or specialist.

Device compliance

Dermaray medical devices are manufactured to strict ISO quality control standards AS13485 and meet or exceed the following recognized standards;

- CE electronic device approval
- TGA Class 1 medical device approval
- ACMA electronic device approval
- FCC electronic device approval
- RoHS reduction of hazardous substances (including lead free)

When not to use - UV lamp Therapy

You should not use Dermalay UV lamp if you are undergoing any form of skin treatment, taking any medications or receiving or recently undergone radiation therapy, without first speaking with your health care professional. Dermalay UV lamp should not be used if you suffer from any of the following conditions;

- hyperthyroidism
- suffer from or have a history of skin cancers
- lupus erythematosus
- tumorous skin changes
- diseased hyperphotosensitivity (e.g. xeroderma pigmentosa)
- porphyrin disease
- fluoride tuberculosis or other fluoride processes
- accompanying medical treatment with potential skin damage or intensified photosensitivity
- pregnancy, because there have been no trials conducted

NOTE: If you have any previous or prevailing medical conditions which you think may compromise your health; please seek professional medical advice from a recognized medical specialist prior to use of UV phototherapy.

Hazards when using Dermalay - UV lamp

Dermalay UV lamp has been built to international ISO quality control standards in compliance with recognized safety standards. The equipment can only be used;

1. for that purpose for which it was intended,
2. when in perfect working order and
3. In accordance with all applicable laws, rules and regulations.

Improper use, or use contrary to these instructions, can cause serious damage to the operator's health and/or third parties (including damage to the skin and eyes) as well as potentially damaging the equipment.

Proper usage

Dermalay UV lamp is a UV lamp appliance for the treatment of skin diseases and hair loss. Any other use of the equipment going beyond this shall be deemed improper and may be hazardous. The operator may use the equipment only after reading this user guide in full and accepting any direct or indirect results. Failure to do so may render the manufacturer's warranty invalid. You must;

- a. Adhere to all the information contained in the operating instructions
- b. Adhere to the schedule for inspection and maintenance work
- c. Adhere to the general and specific safety information and safety regulations contained in these operating instructions as well as the prevailing accident-prevention regulations.

Your UV lamp Pack inclusions.

Your Dermalay UV lamp pack contains one (1) each of the following items:-

- Dermalay UV lamp
- Universal Mains power supply / battery charger
- UV lamp safety goggles compact (patient)
- UV lamp safety goggles large (patient / helper)
- Power cord
- Clear plastic distance guide and scalp attachment
- Quick-Start user guide

A Free copy of User Instruction Manual is reserved for you to download at www.dermalay.com.au

Optional Extra's include (price on application)

- printed copy of User Instruction Manual
- CDROM copy of User Instruction Manual
- Spare distance guide
- Spare scalp attachment
- Treatment Packs
- Spare Dermalay rated; medical grade UV Bulbs

If any component is missing, please contact your place of purchase immediately prior to using your device.

Spare Parts – Bulb Replacement

A UV bulb gradually loses intensity while in use, but also due to mechanically starting and the nature of how fluorescent bulbs operate. As Dermalay® - UV intelligently manages bulb activation and power regulation, a bulb in a Dermalay® - UV will have a longer than normal effective life span and maintain its useful intensity longer. Refer to Chapter “Bulb replacement” for specific bulb replacement instructions.

UV bulbs need to be replaced on a regular basis if any ONE of the following situations occurs;

- If bulb has been used for ~300 hours
- If the bulb is 2~3 years old
- If the bulb becomes very grey or blackened
- If the effectiveness of treatment rapidly becomes less
- If the bulb fails to start properly or is damaged
- If a device is used in a clinic or professional environment where it is used more frequently, bulbs should be replaced more often, at least every 12 months.

WARNING: Use only genuine Dermalay® - UV supplied replacement bulbs. Using a non Dermalay® - UV supplied replacement bulb will damage your device and is not covered by any warranty. The non-standard bulb will also be damaged. Damage of this nature is explicitly not covered by any warranty. Fire or explosion may result using a non genuine UV bulb.

Getting started

Dermaray® - UV is different from other UV phototherapy devices. It is battery operated, contains an inbuilt computer including a real time clock and calendar, is fully programmable, very versatile and comes with a universal power supply for charging the batteries.

Dermaray® - UV electronically starts the medical grade UV bulb for an innovative “instant-on” experience. Other phototherapy systems use a mechanical starter that can take up to 30 seconds to ignite the UV medical bulb (seen as a flickering effect.) Dermaray® - UV has no flickering, very little delay and requires a significantly reduced warm up period to reach full UV intensity. Electronically starting the UV bulb ensures longer lasting and sustainable UV output from each UV bulb.

Dermaray® - UV intelligently manages internal power and operates the medical grade UV bulb at high frequency for maximum efficiency. This sustains the energy output of the bulb while also increasing the life span of the bulb. Resulting in more effective treatment and reduced running cost by less frequent bulb replacements. Other systems reliant on mains power operate the bulbs at either 50Hz or 60Hz that is not ideal, resulting in shorter bulb life spans and a more rapid deterioration of the UV energy output.

Dermaray® - UV uses a powerful onboard computer system that is capable of managing multiple patient treatment programs. Traditionally home phototherapy patients need to manually calculate their starting session time, manually time each individual session with an external egg-timer, manually calculate the next session and keep a record of all sessions including date, time and length of each session in a treatment diary, plus manage session frequency and repetition for each body area requiring treatment. Needless to say, this is a complicated procedure for most home phototherapy patients and accidental over exposure would often result in sunburn. Dermaray® - UV is the first hand held unit to perform this service for you and manage your exposure times, frequency and repetition accurately and precisely. It can even keep track of individual area treatments and guard against excessive exposure and accidental repetition of exposures significantly reducing the chance of both over exposure and accidental exposure (both resulting in sunburn.)

Main components of You UV lamp Comb

Top View listing main components

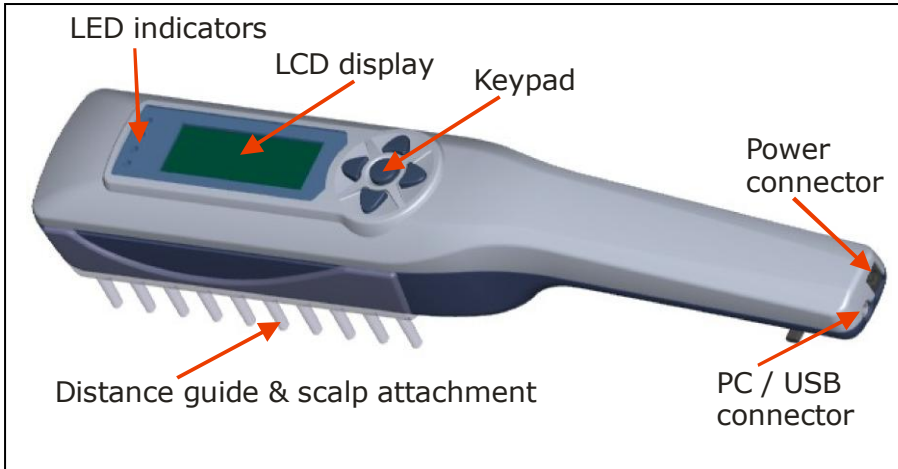

Bottom View listing main components

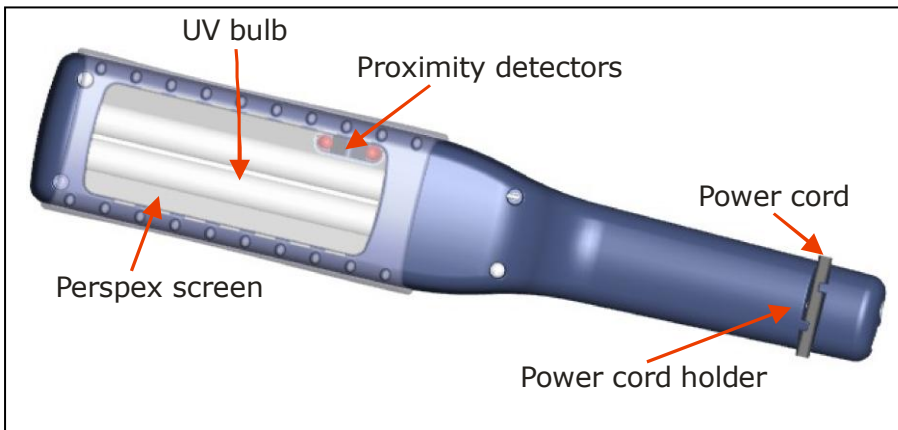

Proximity Detector Explained

Dermaray UV lamp is the safest and most technologically advanced hand held phototherapy system available today. By using a unique and innovative proximity detection system, the brain or on board computer of the Dermaray UV lamp is able to activate the UV lamp modules once it is held in close proximity against a surface (such as a treatment area) and also sound an alarm or deactivate the UV lamps if it is moved away from the surface. This technology protects against accidental exposure and provides a level of safety not found in any other phototherapy device.

NOTE: As a precaution to safe guard against premature bulb damage, Dermaray® - UV will not turn the UV lamp back on within 10 seconds of the last de-activation. This means from time to time, when attempting to start the lamp or during use, a countdown timer may be displayed saying "lamp will start in X seconds."

Battery charging battery care

Dermaray® - UV contains a high quality NiMH rechargeable battery pack and is supplied with a universal (100-240v @ 50-60Hz) battery charger. The power cable with wall connector can be changed to suit different locations with different wall power sockets.

The high quality Japanese NiMH batteries used in the Dermaray® - UV are reliable and not susceptible to the “chemical memory” problems of older NiCad batteries. It is recommended to perform a full charge prior to initial use of your Dermaray® - UV to ensure the best performance and extend the life of your batteries.

Connect the Dermaray® - UV to mains power for a minimum of 12 hours prior to initial use. The CHARGING indicator should flash yellow when charging. The CHARGING indicator will go out (not be lit) when fully charged. However, for the initial charge, leave connected for a total of 12 hours which will include time after the charge indicator stops. Future charging is completed once the yellow CHARGING indicator goes out (not be lit.)

After the initial long charge, Dermaray® - UV can be charged between each use and disconnected from charge once the battery charge indicator shows battery full, or it can be charged when the unit indicates low battery.

Dermaray® - UV can be connected to mains power when battery low indicator sounds. The low battery indicator will sound and display a low battery message with approximately 10 minutes of treatment time left and again with 5 minutes left. Batteries will charge at a reduced rate while the device is in use, however it is recommended that treatment be suspended while the batteries are charging. Fully charged batteries will give approximately 45 minutes of treatment time; this time may be reduced if the device has not been charged for some time.

The battery charger that is built into the unit is intelligent and protects against over-charging and resulting battery damage by constantly measuring battery voltage and temperature. When connected to power and charging the LED indicator “charging” will glow yellow, see below. Note batteries will not charge if the device is too hot or too cold.

Battery Charging Indicator Lights

Figure 1: Showing charging yellow indicator light.

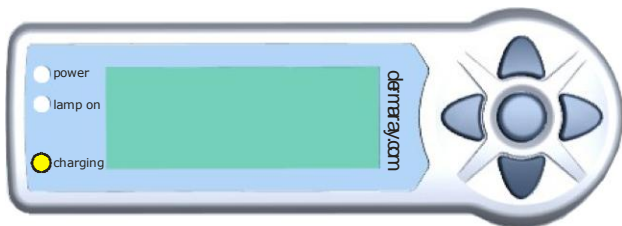
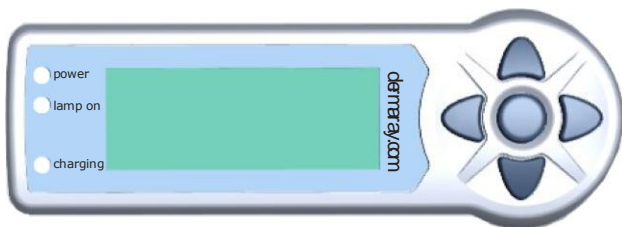

Figure 2: showing battery charge completed. Indicator lights off.



NOTE: During charging the UV lamp handle may become warm. This is normal operation. Batteries will not charge if the device is too hot or too cold.

NOTE: Battery life while in standby is around 2~3 months. If Dermaray UV lamp is not used for a number of weeks it is suggested to fully charge the batteries prior to the next use. Batteries may be completely flat if Dermaray UV lamp has not been used for some time.

General Operations

Dermaray® - UV can be configured in different ways for different treatment purposes. The default and standard configuration is NB-UVB or Narrow Band UVB-311. The available configurations are as follows;

- **NB-UVB, narrow band UVB, 311nm** – primarily for treatment of psoriasis, vitiligo, dermatitis and other inflammatory or immune response conditions. This is the default configuration and suits 95% of patients.
- **WB-UVB, wide band UVB, 295-320nm** – primarily for Vitamin D deficiency and Seasonal Affective Disorder and treatment when NB-UVB has proven ineffective.
- **UVA** – primarily for medical treatment of Alopecia Areata hair loss, tanning and other auto immune conditions. It is not suitable for any other form of hair loss treatment. Also used in conjunction with PUVA for psoriasis.
- **Woodlamp** – medical diagnostic equipment uses only.

Please ensure that you have received the appropriately configured system for your treatment.

Setup and configuration

Prior to commencing treatment, you should have fully charged the battery in the Dermaray® - UV as detailed in section prior. Do not activate the Dermaray® - UV unless you have firstly charged the battery and read these instructions in full.

Dermaray® - UV comes fitted with a distance guide comprising of a number of clear plastic teeth. This guide establishes the correct distance between the lamp and exposure area, makes scalp treatment more convenient and effective and allows proper operation of the proximity detection system. Permanent removal of this distance guide is not recommended and may lead to accidental over exposure, burning and failure of the proximity detection safe guards. Temporary removal is acceptable for cleaning or maintenance purposes only. The distance guide slides off and also slides and clicks back into place.

Common sense must be applied to any phototherapy treatment program, always err on the side of caution. If unsure of any facet of treatment or operation, contact the person whom supplied your device or your supervising doctor.

Dermaray® - UV can store details for 10 patients, each with up to 32 treatment areas. If one patient has more than 32 treatment areas, configure the additional areas under another patient (e.g. Patient 1a and Patient 1b.)

Establishing a treatment program

Phototherapy treatment is different for each person. Any phototherapy program should be considered a guide and may need to be adjusted on an individual basis or in consultation with your health care professional. Dermalary UV lamp however, generally automates this process for you and uses proprietary methodology based on established best practices. There are many variables including but not limited to the following that are considered;

- Patient skin type
- Disease being treated
- Areas requiring treatment

Once programmed, Dermalary UV lamp will intelligently suggest a starting exposure time for your individual condition (based on the information above) and create an entire treatment program specifically for you. This treatment program will be automatically managed and increase at a rate suitable for your skin type and condition, to a maximum exposure level, also appropriate for your situation.

Once the suggest treatment program is completed and your maximum exposure reached, a less frequent maintenance program will then be suggested and used for all further treatments.

WARNING: Dermalary UV lamp is incapable of determining your suitability for phototherapy, your medical background and assessing any adverse reactions to treatment that you may experience. Therefore, common sense must always prevail and you, or a doctor, must monitor your individual condition and results of each treatment session.

Using the UV lamp

Dermalary UV lamp should be held against the treatment area and moved slowly if advised around the surface for the allocated time. For stubborn areas Dermalary UV lamp can be held on one place for several minutes or for the duration of treatment if required. Moving Dermalary UV lamp too quickly may result in a warning alert and deactivation of the UV lamps.

Waking your UV lamp: The WAKE command

Operating and programming will be explained in more detail throughout this guide. Firstly, it is important to learn how to Wake Dermalary UV lamp. This feature will be called "WAKE" throughout this User's Guide.

NOTE: Do not perform this function until this document has been read in full.

Operating and programming will be explained in more detail throughout this guide. Firstly, it is important to learn how to Wake Dermaray UV lamp. This feature will be called WAKE throughout this User's Guide. Normally the Dermaray UV lamp is in SLEEP mode. To WAKE Dermaray UV lamp press and hold the ENTER key for 3 seconds (central round button, see below.) Dermaray UV lamp will beep and the top green indicator will be on. You will see information presented on the display. If left unattended Dermaray UV lamp may return to sleep and need to be WAKEN again. Perform the WAKE function for the first time only after fully charging the batteries.

The "WAKE" command, press and hold ENTER button for 3 seconds.

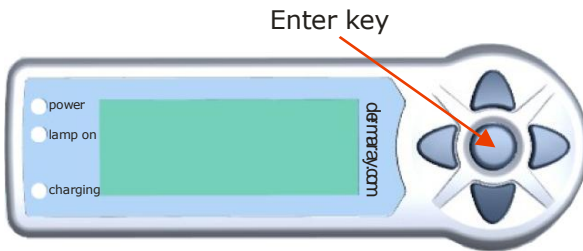

Dermaray Setup Wizard is started when the lamp is first activated.

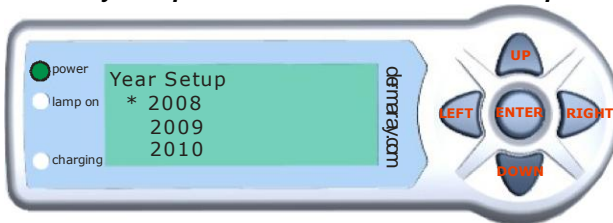

To turn off and enter sleep mode

Dermaray Welcome Screen is shown on subsequent WAKE commands after completion of the Setup Wizard

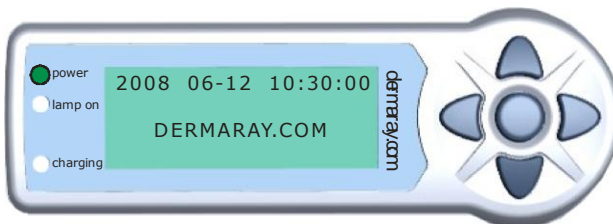

To turn Off UV lamp (enter sleep mode) at any time and at most menus to turn off Dermaray UV lamp, PRESS and HOLD the ENTER button for 3 seconds. This will turn the unit OFF and is called SLEEP mode.

Dermaray UV lamp: Setup Wizard

When Dermaray UV lamp is WAKEN for the first time, it will present a SETUP WIZARD. On subsequent activations Dermaray UV lamp will present the WELCOME SCREEN. In some instances Dermaray UV lamp may present the SETUP WIZARD again, for example after a software upgrade a complete software reset or manual activation of the Setup Wizard. Please now follow the procedure below;

1. Fully charge Dermaray UV lamp
2. WAKE Dermaray UV lamp
3. Proceed through Setup Wizard as follows.

The SETUP WIZARD is an automated setup procedure; it will prompt you for system information as well as patient treatment information. It is suggested to make some notes prior to starting the SETUP WIZARD. The Setup Wizard must be completed within 25 minutes otherwise Dermaray UV lamp will return to SLEEP. (If this happens, the information will need to be entered into Dermaray UV lamp manually via the SYSTEM CONFIG MENU and TREATMENT CONFIG MENU.) Information can easily be amended or deleted at a later stage. The SETUP WIZARD will ask the following questions;

- Date (year, month, day)
- Time (hour and minutes in 24:00 format)
- Patient name
- Patient skin type
- Disease
- Treatment areas (by area name e.g. scalp, chest, left leg etc)

Setup Wizard: Flow Chart

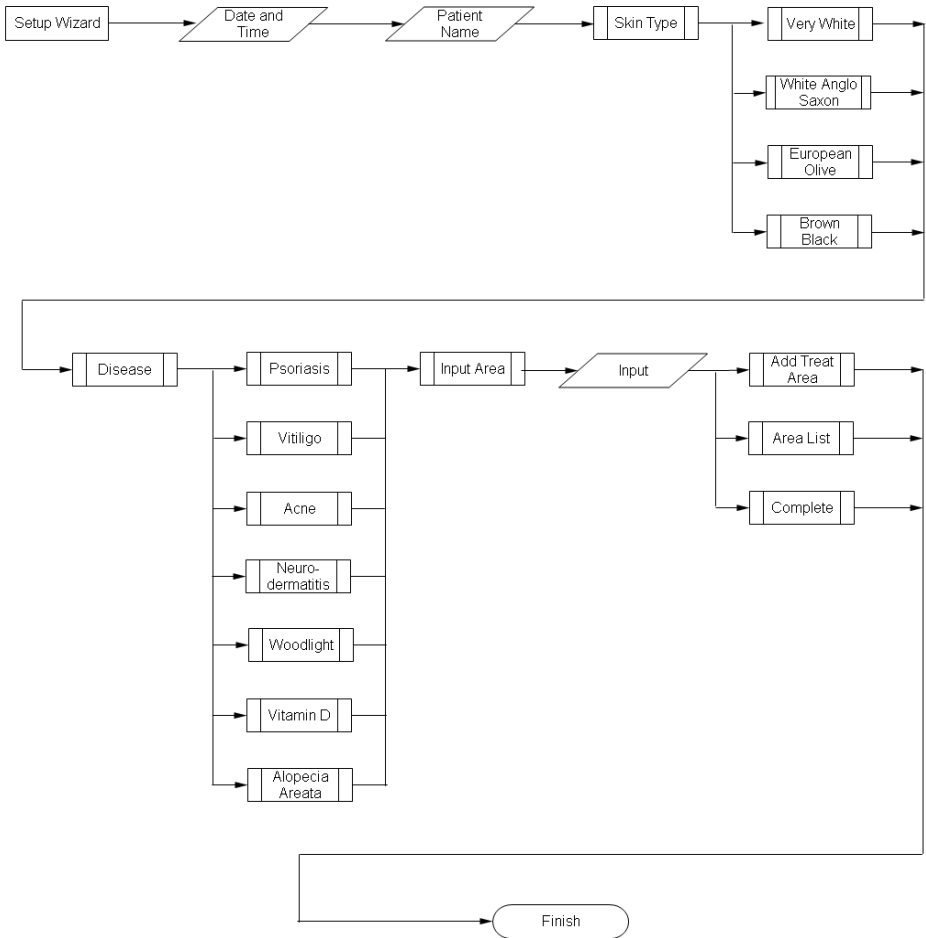

Setup Wizard: Date (year, month, day)

To begin setting up Dermaray□ - UV lamp for initial use, please WAKE the device by pressing and HOLDING the “ENTER” key for 3 seconds
Enter key

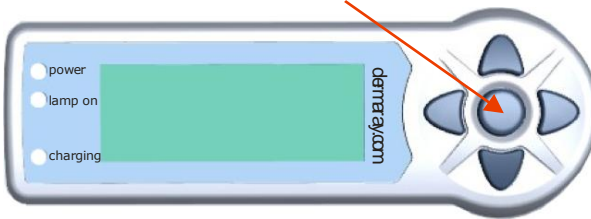

Select the current YEAR by pressing or holding the UP and DOWN keys and then press ENTER. The display will scroll up and down.

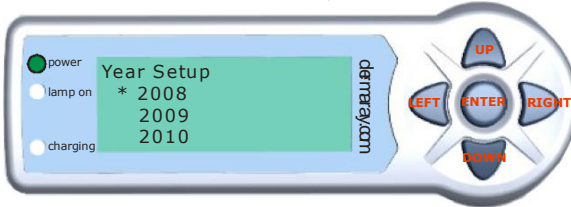

Select the current MONTH by pressing or holding the UP or DOWN keys and then press ENTER. 1 = January, 2 = February, 3 = March etc.



Setup Wizard: Continued

Select the current DAY by pressing or holding the UP or DOWN keys and then press ENTER. 1 = 1st of the month, 2 = 2nd of the month, 3 = 3rd of the month etc.

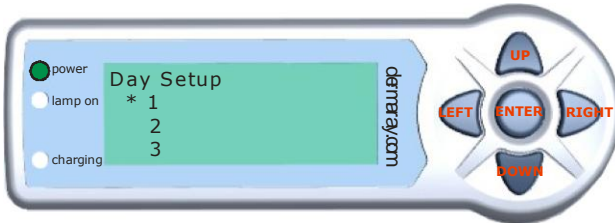

Select the current HOUR in 24 hour format (00:00) by pressing or holding the UP or DOWN keys and then press ENTER. 1 = 1:00am, 6 = 6am, 18 = 6pm, 0 = midnight etc.
etc.

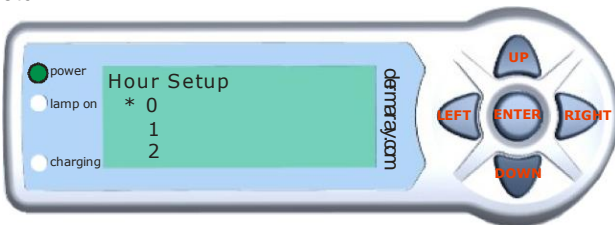

Select the current MINUTE in 24 hour format (00:00) by pressing or holding the UP or DOWN keys and then press ENTER. 1 = 1 minute past the hour, 15 = 15 minutes past the hour, 30 = 30 minutes past the hour, 45 = 45 minutes past the hour etc.



Setup Wizard: Continued

After entering the Date and Time either 1.Complete the setting or 2.Discard & Exit.

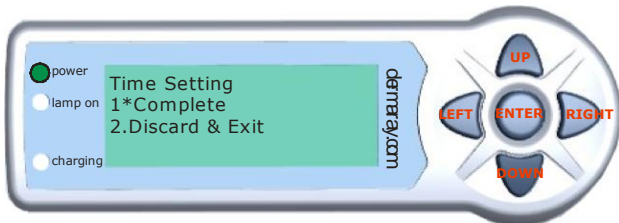

Setup Wizard: Input Patient Name

Enter the patient name by selecting letters from the alphabet. Press or hold the LEFT or RIGHT arrow to scroll through the alphabet, press ENTER to select the highlighted letter e.g. "A" and repeat scrolling for subsequent letters. "_" = space. To delete an incorrect letter select "Del" to delete the last letter(s). To finish entering the Patient Name press the ENTER button after selecting the last letter. Press either the ENTER button or select "Exit" to finish using the Setup Wizard.

NOTE: UP and DOWN arrows can be used for advanced editing to swap between the input line and alphabet selection line. A maximum of 10 Patient Names can be stored.

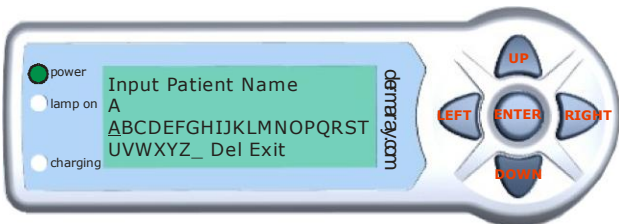

Setup Wizard: Skin Type

Select the patient SKIN TYPE by pressing or holding the UP or DOWN keys and then press ENTER. Options that do not appear on the LCD are included in the picture above. The list will automatically scroll. A confirmation page will display to confirm your selection. Skin types can be further explained as;



Skin Type / Description

1. VERY WHITE - Celtic type:

- Light skin, red or fair haired, blue or green eyes, freckles.
- Quick to sunburn; little or no bronzing even after repeated sun exposure.

2. WHITE ANGLO SAXON - European type:

- Fair-haired, blue, grey or green eyes.
- Almost always sunburn; moderate bronzing after repeated sun exposure.

3. EUROPEAN OLIVE – Dark skinned European type:

- Light brown or brown hair, brown eyes.
- Sometimes sunburn; progressive bronzing after repeated sun exposure.

4. BROWN BLACK – African, or black coloured type:

- Dark brown or black hair, brown eyes.
- Rarely sunburn, rarely bronze or tan.

5. CHILD – Small children

- For very sensitive skin type such as children or the elderly
- This setting can be used for a very conservative treatment

Selecting a skin type allows Dermalay UV lamp to adjust exposure programs to best suit your sensitivity to light. Lighter skin has shorter exposures than darker skin. Darker skin types will have longer exposures.

Setup Wizard: Disease Type

Select the patient DISEASE TYPE by pressing or holding the UP or DOWN keys and then press ENTER. Options that do not appear on the LCD are included in the picture above. The list will automatically scroll. A confirmation page will display to confirm your selection.

Selecting a disease type allows Dermaray[®] - UV lamp to calculate an appropriate treatment program for different conditions while considering your skin type.

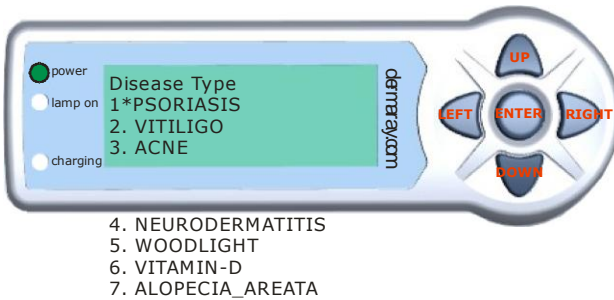

Setup Wizard: Treatment Area's

Treatment Areas are locations on the body that require exposure such as Scalp, Face, Left Leg, Right Arm etc. Up to 32 locations can be entered and treatment times and exposures are individually recorded for each area. Individual areas can be treated separately or all areas can be treated in turn in one session. There may also be only one area, such as for treatment for Hair Loss.

Enter the Treatment Areas by selecting letters from the alphabet. Press or hold the LEFT or RIGHT arrow to scroll through the alphabet, press ENTER to select the highlighted letter e.g. "A" and repeat scrolling for subsequent letters. "_" = space. To delete an incorrect letter select "Del". To finish entering the Patient Name press the ENTER button. Press either the ENTER button or select "Exit" to finish using the Setup Wizard. A confirmation page will display to confirm your selection. After the first Treatment Area is added, Dermaray[®] - UV lamp will present the "Treatment Area" menu.



NOTE: UP and DOWN arrows can be used for advanced editing to swap between the input line and alphabet selection line. A maximum of 32 Treatment Areas can be stored per Patient Name.

To view add additional treatment areas select 1. Add Treat Area, select 2. Area List to view already entered Treatment Areas or select 3. Complete when finished entering all Treatment Areas.

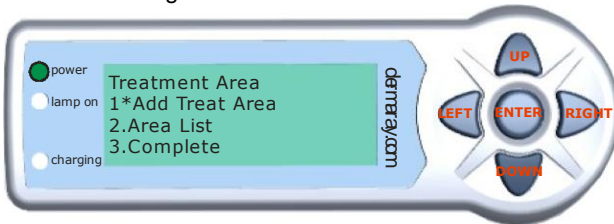

Setup Wizard: Completed

Once Date & Time, Patient Information and Treatment Areas have been entered the Setup Wizard is now complete. Dermalay® - UV will return to the Welcome Screen. The current Date and Time should display. If no button is pressed, Dermalay® - UV may return to SLEEP and need to be WAKEN again. Information entered via the SETUP WIZARD is stored in memory and also protected by battery backup.

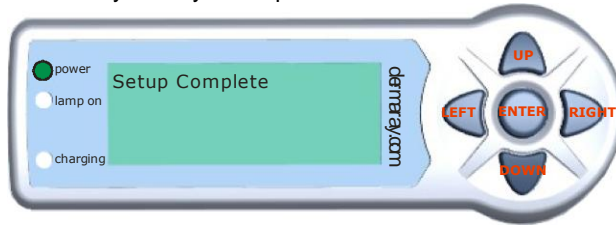

What to do if the Wizard is not presented

Under some circumstances, the Setup Wizard may not be presented or may need to be started manually. In order to resolve this issue for a brand new Dermalay UV lamp please follow the instructions titled "A Software Reset" "Performing a Reset Function"

Subsequent Activations: Welcome screen

After initial completion of the SETUP WIZARD and AWAKE on subsequent occasions, the Dermalay UV lamp will present a WELCOME SCREEN. The WELCOME SCREEN displays the date, time, logo and battery voltage.

At the WELCOME SCREEN Dermalay □ - UV lamp behaves in a similar way to a traditional non-computer controlled UV lamp comb, it may be activated or deactivated on a manual basis. Or at the WELCOME SCREEN pressing ENTER again will access treatment programs and other configuration and automated features.

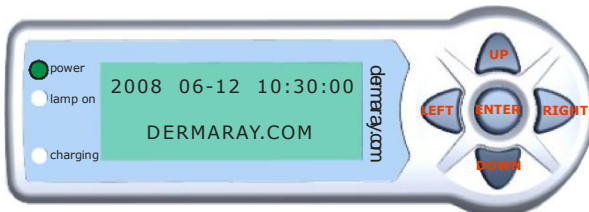

WELCOME SCREEN



MANUAL MODE



AUTOMATED MODE

Entering Manual Mode

Dermaray UV lamp is a very sophisticated device, but it can also be used in a similar fashion to a manual phototherapy system by simply being turned on and off. This mode may be useful for people who are;

- unable to program the device successfully
- do not wish to use an automatically generated program
- are already familiar with manual phototherapy
- continuing a pre-existing treatment program
- other non-standard applications for UV lamp therapy
- as prescribed by a doctor
- have already configured a DEFAULT USER and wish to proceed with their next pre-defined treatment session with no additional change, to programming

Three manual modes and one short cut key are available at the WELCOME SCREEN as follows;

- **UP** manual activation.
- **DOWN** activation for set time.
- **LEFT** for HELP menu.
- **RIGHT** begin next programmed session ALL areas for default user.

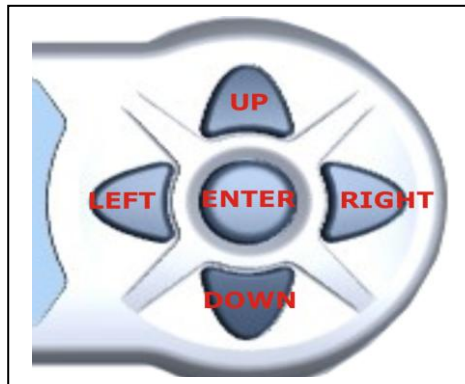

Manual Activation – UP button

WAKE Dermalay[□] - UV lamp, by pressing and holding the ENTER key for 3 seconds. Then at the WELCOME screen;



Press and hold the UP button for 3 seconds to manually activate the lamp. Dermalay[□] - UV lamp will start counting how long it is activated for. Once started a treatment surface must then be detected before the lamp will activate. This mode must be stopped manually.

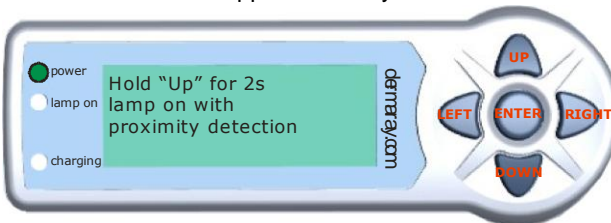

Move the UV lamp to the appropriate area requiring treatment.



Once a surface is detected the UV lamp will turn on and the treatment will be administered. The RED LED will also be activated to indicate the UV lamp system is active.



NOTE: This is a timer that increases with no set limit. In this mode, the lamp will remain on until manually de-activated, or a de-activation is triggered or caused by another event such as a low battery.

Once the UV lamp has been activated, pressing any key will allow the current treatment to be stopped, to Continue or to be paused with the option to Cancel or Resume.

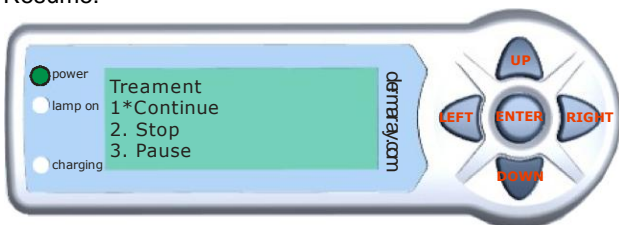

Manual Activation - Down button

WAKE Dermalay - UV lamp, by pressing and holding the ENTER key for 3 seconds. Then at the WELCOME screen



Press and hold the DOWN button for 3 seconds to manually activate the UV lamps, with proximity detection and with a user defined countdown timer (shut off will occur once timer has expired).

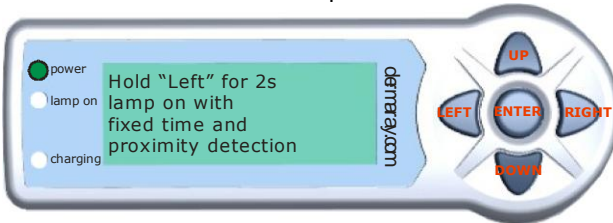

Enter the time in SECONDS to manually turn on the UV lamp. Press or hold the LEFT or RIGHT arrow to scroll through the numbers; press ENTER to select the highlighted number. E.g. 60 seconds = 1 minute, 180 seconds = 3 minutes. To delete an incorrect number select "Del", to finish entering the number press the ENTER button or select "Exit"



After entering the Manual Treatment Time either 1.Complete the setting and begin the treatment, 2.Discard & Exit or 3.Cancel and return to the Input TIME screen. Once started a treatment surface must then be detected before the lamp will activate.

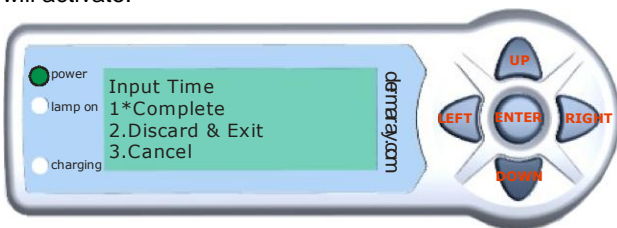

Move the lamp to the appropriate area requiring treatment

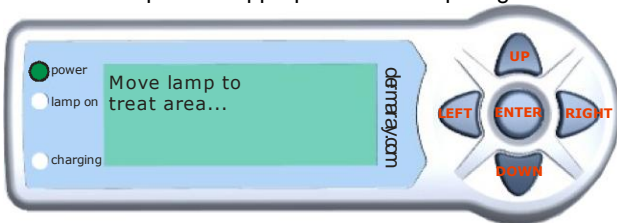

Once a surface is detected the lamp will turn on and the treatment will be administered. The RED LED will also be activated to indicate the UV system is active.



NOTE: This is a timer that decreases from the specified time limit. In this mode, the lamp will remain on until automatically de-activated when the timer reaches zero or manually stopped by pressing ENTER and selecting STOP, or when proximity detection pauses the countdown.

Manual Activation next treatment – RIGHT button

Once the SETUP WIZARD has been completed, at the WELCOME SCREEN, pressing and holding the RIGHT button for 3 seconds will invoke the next treatment session for the last user for all areas. This is an extremely useful feature. It allows the primary user of Dermalay® - UV to invoke their next treatment program quickly and easily without accessing extended programming menus. Dermalay® - UV will know the next appropriate session duration and also protect against too frequent exposures by providing warning notes.

WAKE Dermalay® - UV lamp, by pressing and holding the ENTER key for 3 seconds. Then at the WELCOME screen, press and hold the RIGHT key for 3 seconds.



A confirmation page will display the last Patient Name and advise All Areas Treatment has been automatically selected. Then move Dermalay® - UV lamp to the first treatment area. If the last treatment was interrupted, Dermalay® - UV lamp will resume from the point it was interrupted

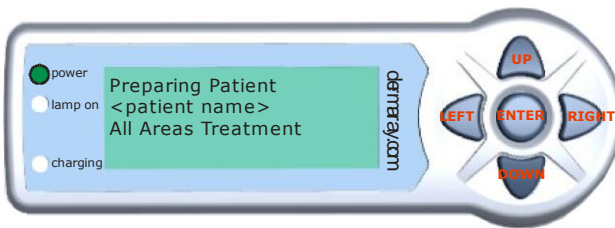

Accessing HELP system – LEFT button

WAKE Dermaray[®] UV lamp, by pressing and holding the ENTER key for 3 seconds. Then at the WELCOME screen, press and hold the LEFT key for 3 seconds to access the HELP MENU



Entering Programming Mode

WAKE Dermaray UV lamp, by pressing and holding the ENTER key for 3 seconds. Then at the WELCOME SCREEN press ENTER again once to enter the MAIN MENU for programming. If a button is not pressed within 4 seconds the MAIN MENU will exit and the WELCOME SCREEN will be displayed again. Simply press ENTER again to access the MAIN MENU. If Dermaray UV lamp is left unattended for a short while, it will exit programming and return to the WELCOME SCREEN. If still left unattended it will also return to SLEEP to conserve batteries. If this happens, please WAKE the unit and begin programming again.



NOTE: During programming, to exit a menu press the RIGHT button to return to the previous menu or select EXIT.

Main Menu and its four options;

The main menu had four options

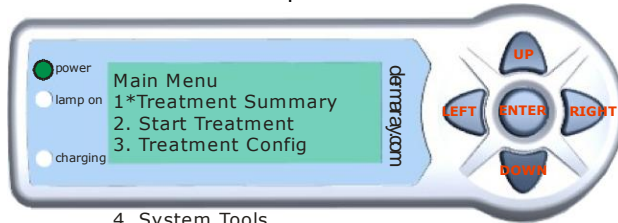

Treatment summary displays a list of Patients and statistics for each treatment area for each individual patient including skin type, disease, the last session time and total exposure time

Start Treatment: allows a user setup via the SETUP WIZARD or entered manually to start either all treatment areas or a selected individual treatment area. This menu also allows for manual activation or manual activation with a fixed time.

Treatment Config: Allows existing patients to be modified or deleted, plus new patients to be added.

System Tools: System Tools provides access to the Setup Wizard, System Information, Tube/Bulb Configuration, LCD Back Light Control, Power Control, Time Setup, Software Synchronisation with a PC, Reset to Default Settings, Software Upgrade from PC

Exit: Leave the main menu and return to the Welcome Screen.

Main Menu: 1. Treatment Summary

From the MAIN MENU, selecting 1.Treatment Summary will display a list of configured patient names, there may be any number of patients configured. Make a selection and press ENTER to view the treatment areas that are configured for that user.

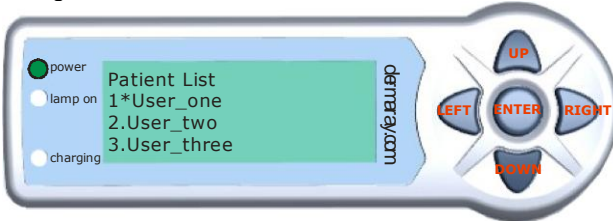

From the TREATMENT AREA MENU, selecting a Treatment Area from the list will display detailed information about that area, there may be any number of Treatment Areas configured. Make a selection and press ENTER to view the additional information.

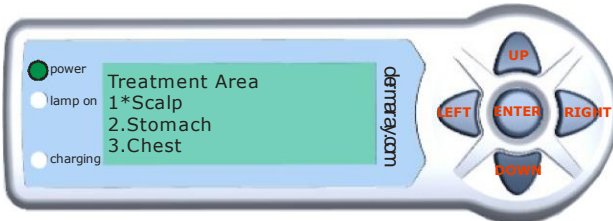

Information contained for each treatment area includes the above details, examples included. To exit these menus press the RIGHT button. To return to the MAIN MENU or WELCOME SCREEN continue pressing the RIGHT button



Total Exposure: 180 sec

Main Menu: 2. Start Treatment

From the MAIN MENU, selecting 2.Start Therapy will display the START THERAPY MENU

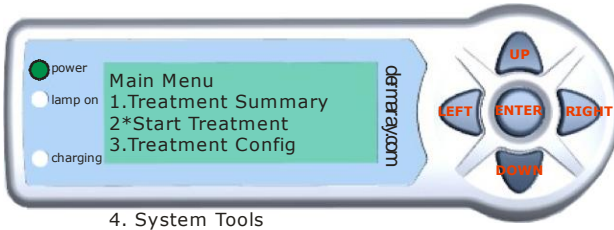

4. System Tools

From the START TREATMENT MENU, selecting 1. Programmed Areas will present a PATIENT LIST. Manual On/Off and Manual Fixed time are the same function available via UP and DOWN arrows at the WELCOME SCREEN.

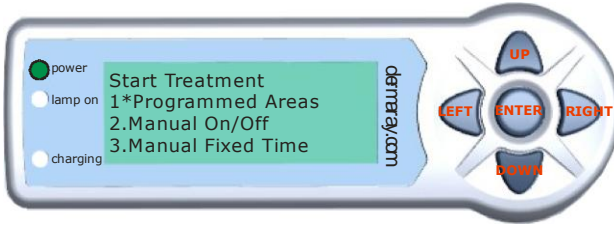

After selecting a Patient from the PATIENT LIST a TREATMENT AREA menu is displayed.

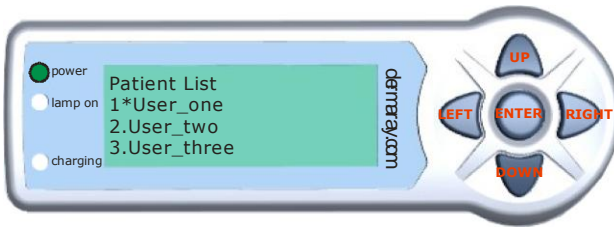

At the TREATMENT AREA menu select 1.All Areas to treat all pre-programmed areas or select an individual area to perform treatment on.

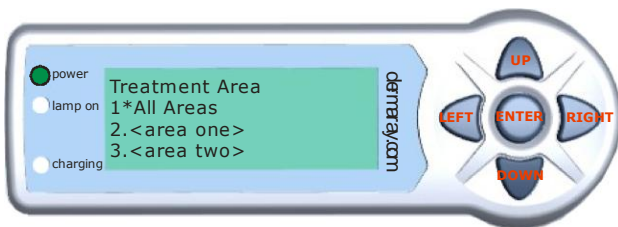

After making a selection at the TREATMENT AREA MENU above, the AREA MENU will be presented at the start of each new area requiring treatment – only once if an individual area was selected. Each Treatment Area can either be 1.STARTED, 2. SKIPPED or 3.RESTARTED. The system will automatically move to the next area in succession

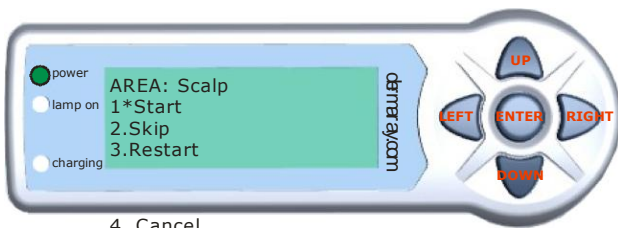

Move the UV lamp to the appropriate area requiring treatment

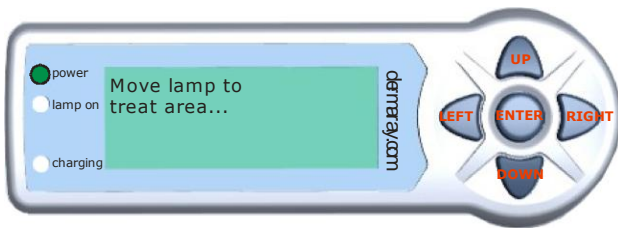

Once a surface is detected the lamp will turn on and the treatment will be administered. The RED LED will also be activated to indicate the UV lamp is active. The timer will display with the time REMAINING for this treatment session. A session can be STOPPED, PAUSED or SKIPPED by pressing ENTER during the session



Main Menu: 3. Treatment Configuration

From the MAIN MENU, selecting 3.Treatment Config will display the TREATMENT CONFIG MENU

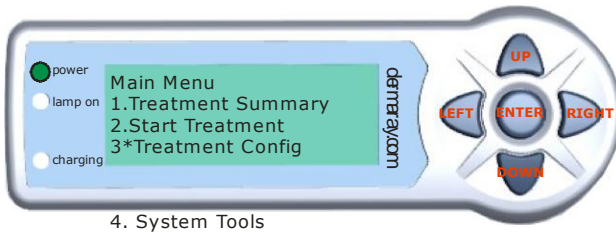

The TREATMENT CONFIG MENU above. Option 1. Add Patient will create a new patient profile – a similar process as the SETUP WIZARD 2. Patient List will allow an existing patient to be edited or deleted.



Main Menu: 4. System Tools

The System Tools menu should be used with some caution. These options typically control vital components of Derrmaray® - UV and some functions, if selected, cannot be easily undone.

From the MAIN MENU, selecting 4.System Tools will display the SYSTEM TOOLS MENU.

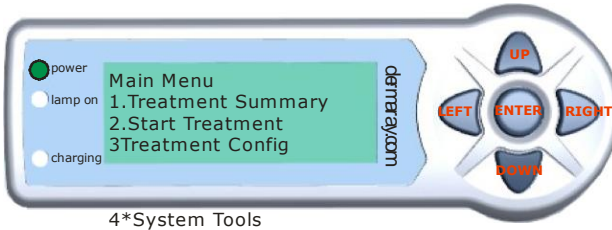

4*System Tools



4.Back Light Cntrl
5.Power Cntrl
6.Time Setup
7.Syscfg Sync
8.Reset to Default
9.Software Upgrade

System Tools - Menu functions

The SYSTEM TOOLS MENU functions are as follows;

1. System Info: Displays the current Software Version Number, the unique Serial Number of the device, the type of bulb installed (NB-UVB, WB-UVB or UVA etc.) and other fixed system information.

2. Setup Wizard: This function allows for the easy addition of a new user, a similar process to the Patient Information system entered during the original Setup Wizard, without modifying the current system Date and Time.
3. Indicates battery strength, and re-charge status.
4. Proximity Sensor controls. On/Off settings, (proximity sensor enabled or disabled).
5. Treatment Notify. Standard setting is set on (20 seconds) unit will emit a beep sound at a set interval 20, 30, 60 seconds or disabled.
6. Sound Control. Standard setting is on for all sounds and warnings. You can also set warnings only or no sounds at all.
7. Back Light Control: Allows the continual activation of the LCD display backlight, or automatic management. Continued activation will reduce battery life. Automatic management will turn off the LCD backlight when no new information is available, and turn on the LCD backlight when there is new information to present on the display (default is automatic).
8. Power control: Allows the continual activation of the lamp without automatic shut down (default is automatic.)
9. IR-Sensitivity. This control effects the proximity sensor sensitivity, default is medium, change to low or high if lamp is being activated early or going off during treatmentl.
10. Tube Config: Allows selection of the installed UV tube, plus manual tube life expectancy and other tube management features.
11. Time Setup: Set new Date and Time information.
12. Reset to Default: This function will delete all user entered information, historical data and patient information. This is useful if giving the device to a new patient or configuring with a new bulb or for a new patient. WARNING: Bulb life span is also reset.
13. Hardware Tests. Used to test hardware functionality of the UV Lamp, use only if you suspect a problem with your lamp, use with caution as lamp can be unexpectedly activated, always wear safety goggles when operating lamp.
14. Software Upgrade: A function to upgrade operating system software within Dermanay® - UV. This function would only be performed with an original Dermanay® - UV upgrade-kit.

Automatic Safety features

Protection against Over Exposure or Over Usage

Dermaray® - UV is the only device available today which incorporates a set of unique features designed to increase safety for the patient including protection against using the system too often (frequency protection) and also against direct over exposure (duration protection.) Frequency protection warning is presented prior to the Duration protection warning if required

Furthermore the Dermaray® - UV lamp is the only phototherapy device that aids in user protection against administering treatments too often by alerting the user if the system is activated within 1 day of the previous treatment

Typically at least one full day's rest is required between phototherapy treatment to allow the skin to recover and signs of overexposure (if any) to become evident. For some conditions, or some patients, extra recovery time may be required. This is the suggested minimum recovery period.

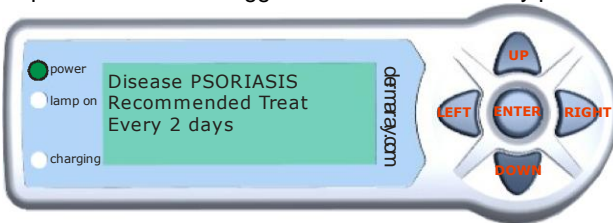

Pressing any button will present the screen above to either CANCEL or CONTINUE with the next treatment



Over Exposure Protection (duration)

Dermaray® - UV helps to protect against overexposure by automatically reducing the next exposure if any redness or burning was experienced from the previous treatment. Redness or burning may take 12~24 hours or more to become noticeable.

Prior to each treatment, the message above will be presented

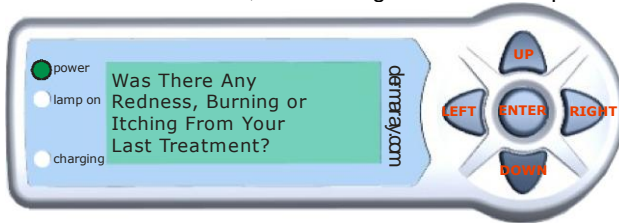

Pressing any button will present the screen, selecting NO will continue with the next treatment as normal and either increase the exposure time if appropriate or continue with the next usual exposure time. Selecting YES will continue the next treatment with a reduced exposure time.

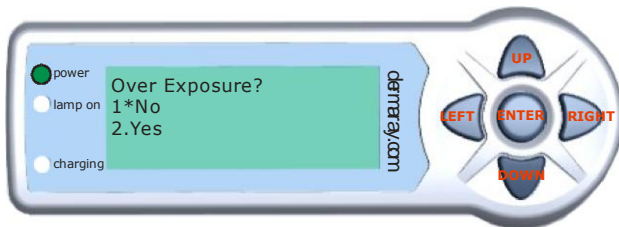

General Use and Operation

Once programming has been completed on your Dermalay UV lamp the duration of your treatment has been calculated automatically. Treatments start off slowly and work up to a maximum of several minutes depending on your condition and skin type. UV phototherapy is recommended at most every two days, allowing your skin to rest between treatments. Daily treatment is not recommended, but if required, should be closely monitored by your health care professional. Sensitive skin may require additional days for recovery between treatments.

Dermalay lamp can be used by either continuously moved over the entire treatment area or held for the entire treatment on one area.

If Dermalay UV lamp is moved too fast, an alert will sound and the display will signal an "IR disconnect" error. This is part of the normal operation. If you continually receive this error, please ensure you are holding the comb flat against the treatment area. Try moving Dermalay UV either faster or more slowly until you find the best method of use for yourself.

It is important to hold Dermalay UV lamp flat against your scalp or treatment area and move it in contact with your skin. Lifting Dermalay - UV to move between treatment areas will cause an IR Disconnection warning. This is part of the normal operation. If lifting and moving between treatment areas is required, setup additional treatment areas or disable proximity detection via the System Tools menu.

Online Help

In addition to this user guide, we are pleased to document the main features of the UV lamp via online videos.

Links to view videos

- [Charging the battery](#) or <http://www.youtube.com/watch?v=-Kmoz10sj2g>
- [Completing the Setup Wizard](#) or <http://www.youtube.com/watch?v=7w-xMKVVpdU>
- [How to Start and Use](#) or <http://www.youtube.com/watch?v=IEDHknYmxoI>
- [Proximity Detection Explained](#) or <http://www.youtube.com/watch?v=wOcqjIUURCc>
- [Hardware Test & Feature Overview](#) or <http://www.youtube.com/watch?v=Vaertznfhn0>

For additional advice, discussion and assistance using your Dermaray UV lamp please visit and join our support forum. This is the best place to ask questions, search for answers and learn more about your Dermaray[®] - UV. Plus meet and chat with other users.

<http://www.beatpsoriasis.com/phpBB3>

Doctor and Specialist PC Connectivity

The Dermalay UV lamp when supplied by your Medical or Skin Specialist, May have already been pre-configured with your treatment plan and your personal details.

“Do not under any circumstance change or amend this”.

Your therapist or consultant has already acquired the optional connectivity package which permits connection of your device with the Dermalay Specialist Software program, Your UV lamp will be connected to the specialists Personal Computer system using an optional USB connection cable for programming and input of your personal details and treatment(s).

This feature allows the specialists to calibrate the UV lamp to your individual program, and may include one of or all of the following options;

1. Allows a doctor or specialist to establish a customised treatment program for particular patients or conditions such as small children or patients hypersensitive to phototherapy.
2. Locking a Dermalay- UV lamp to a specific patient by name.
3. Establishing a set customised treatment program for individual patients.
4. The ability to LOCK or PRESCRIBE a predetermined program by either date and time or number of sessions to administer, e.g. after 3 months or 50 sessions, Dermalay UV lamp will need to be returned to the doctor to PRESCRIBE additional sessions or treatment and for a patient checkup by their doctor/Hair specialist.
5. This feature allows for greater regulatory and safety control.
6. To upgrade firmware for your unit.

WARNING: Use only genuine Dermalay UV lamp supplied USB connector cable. Using a non Dermalay UV lamp supplied USB connector cable will damage your device and is not covered by any warranty. Damage of this nature is explicitly not covered by any warranty. Fire or explosion may result using a non genuine USB cable.

Bulb replacement guide

The following section describes how to change or replace a bulb. Instructions here are a guide only, this procedure should be undertaken strictly by a person suitably qualified or experienced with electronic equipment and tools.

WARNING: Use only genuine Dermaray® - UV supplied replacement bulbs. Using a non Dermaray® - UV supplied replacement bulb will damage your device and is not covered by any warranty. The non-standard bulb will also be damaged. Damage of this nature is explicitly not covered by any warranty. Fire or explosion may result using a non genuine UV bulb.

NOTE: Ensure Dermaray® - UV is NOT connected to mains power and is currently OFF or ASLEEP. If the bulb is broken or shatters, wash hands immediately and observe general chemical handling cautions when disposing of the debris.

Detach the Slide scalp attachment off.



Remove 5 screws, taking note of their specific locations for reassembly.

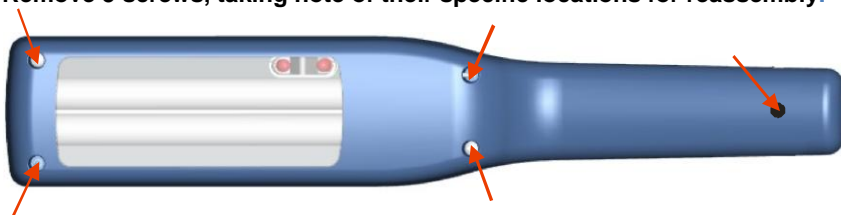

WARNING: Take care when removing screws that the lamp is not accidentally activated. It is suggested to hold the lamp rather than lay it on a flat surface while removing the screws. Note a T10 Torx driver is required for screw removal.

Holding the sides of the "Socket," gently remove the bulb to the LEFT by holding the "Bulb base." Some force may be required. Replace the bulb and reassemble the device. Replacement bulbs can be inserted in any orientation, the polarity is not important

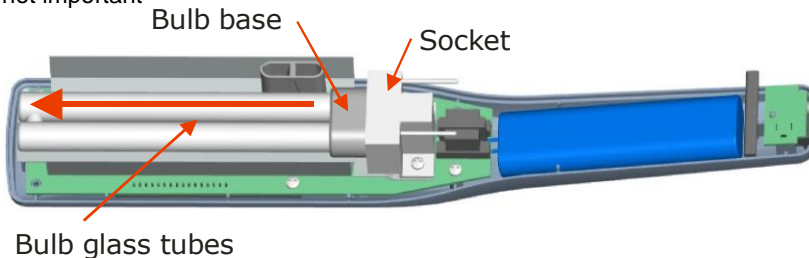

Bulb Life Time and Power Output

Due to the unique method Dermaray UV uses to manage the Philips medical bulbs, there is little loss of power and a significantly higher output over much longer sustained usage. This means one bulb will outlast 3~4 bulbs in other UV lamps, while providing consistently better and more effective therapy by maintaining a higher power output for the duration of the bulb's usable life. The Dermaray UV's unique design maintains in excess of 82% power output after 1500+ hours. A typical mains powered UV device continually loses power with each use and has a 1/2 life of only approximately 300 hours.

Battery pack replacement guide

The following section describes how to change a battery pack. Instructions here are a guide only, this procedure should be undertaken strictly by a person suitably qualified or experienced with electronic equipment and tools.

WARNING: Battery replacement should only be performed by a qualified and approved service centre.

WARNING: Use only genuine Dermalary® - UV supplied replacement battery packs. Using a non Dermalary® - UV supplied replacement battery pack will damage your device and is not covered by any warranty. Damage of this nature is explicitly not covered by any warranty. Fire or explosion may result using a non genuine battery.

NOTE: Ensure Dermalary® - UV is **NOT** connected to mains power and is currently **OFF** or **ASLEEP**. Battery packs should be disposed of in accordance with local environmental laws.

Detach by Sliding scalp attachment off.



WARNING: Take care when removing screws that the lamp is not accidentally activated. It is suggested to hold the lamp rather than lay it flat surface while removing the screws. Note a T10 Torx driver is required for screw removal

Remove 5 screws, taking note of their specific locations for reassembly

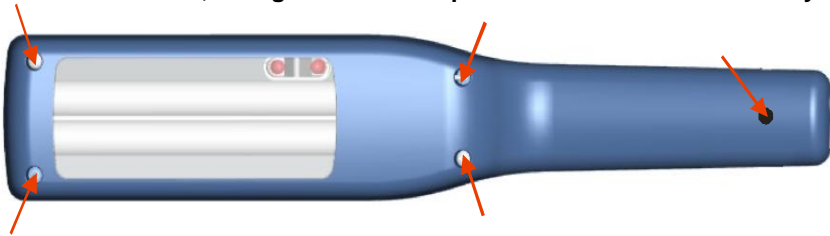

Locate the Battery Pack and Battery Connector Terminals. Disconnect the two connector plugs taking note of where they were connected. Replace the battery pack and reassemble the device

Battery connector terminals

Battery pack

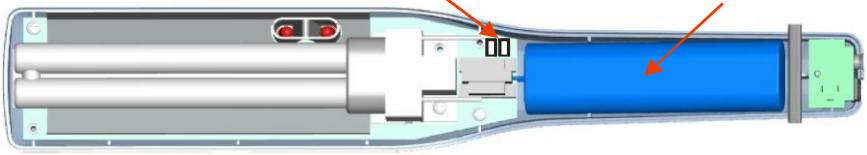

Battery Connector Terminals are shaped to connect in the correct orientation. Power connector (black and red) is the left connector, temperature monitor are blue connectors to the right.

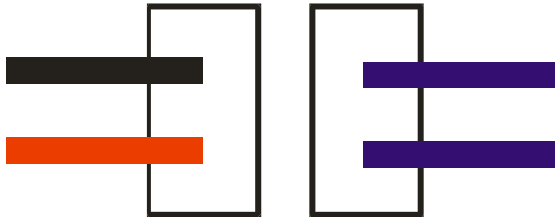

Performing a software upgrade

The following section describes how to upgrade onboard software or firmware. This section should only be followed on explicit instructions from Dermaray or your authorised distributor. The software upgrade feature requires a custom PC connection cable and Dermaray specific PC software. Attempting to access Dermaray features or firmware via non-standard connector cable and / or PC software may cause permanent damage to the Dermaray® - UV.

WARNING: Use only genuine Dermaray® - UV supplied PC connector cable and PC software. Using a non Dermaray® - UV supplied PC connector cable and / or PC software will damage your device and is not covered by any warranty. Damage of this nature is explicitly not covered by any warranty. Fire or explosion may result using a non genuine PC connector cable.

WARNING: Performing a software upgrade will erase all entered and stored information. Dermaray® - UV will need to be reconfigured in the same manner as a new device. This includes all patient information, bulb life timers, treatment information, date and time etc.

WARNING: The Software Upgrade function must not be interrupted. Interruption of a software upgrade may render Dermaray® - UV unusable and a factory repair will be required. Damage of this nature is not covered by any warranty.

1. Ensure that Dermaray® - UV battery is fully charged.
2. Connect Dermaray® - UV to mains power.
3. Take note of the remaining bulb useful life time under System Tools -> Bulb Info.
4. Stop all unnecessary programs on the PC, disable all virus scanners and firewall applications.
5. Attach the supplied PC connector cable to a PC and to the Dermaray® - UV USB connector.
6. WAKE Dermaray® - UV, access the System Tools Menu, and select Software Upgrade, then select YES.
7. Using the supplied software, firstly ERASE the flash.
8. Using the supplied software, upload the new flash.
9. Perform a hardware reset.
10. Reconfigure Dermaray® - UV and re-input the remaining bulb life time

Performing a Reset function

The following section describes how to reset the Dermalay[®] - UV. There are two reset methods; a software reset and hardware reset. The software reset will clear all user memory; all entered and stored information will be lost and unrecoverable. In most instances a hardware reset is adequate, on rare occasions if Dermalay[®] - UV becomes jammed or locked, or after software upgrade a hardware reset may need to be performed. A hardware reset will not erase any stored information in the Dermalay[®] - UV.

WARNING: Performing a software reset will erase all entered and stored information. Dermalay[®] - UV will need to be reconfigured in the same manner as a new device. This includes all patient information, bulb life timers, treatment information, date and time

Software reset

1. WAKE Dermalay UV lamp, access the System Tools Menu, and select Default Reset.
2. When prompted with Reset Config, select YES.
3. All software information is now reset and any stored information is lost.

Hardware reset

WARNING: After hardware reset Dermalay UV lamp will briefly flash its UV lamp modules, ensure the device is face down and not directed at your eyes. Wear appropriate eye protection.

Hardware reset button. Once pressed, the LCD display will flash and beep.

Internal hardware reset button

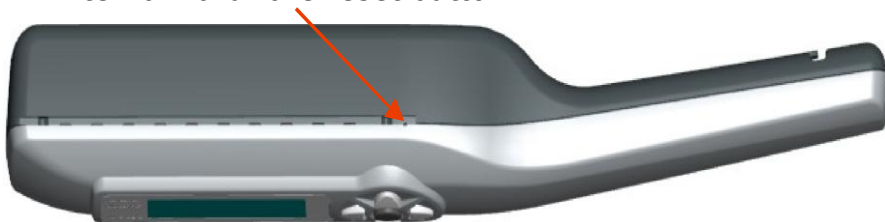

Trouble Shooting Tips

Dermaray UV lamp is a high quality precision device manufactured to the most exacting standards possible. However from time to time problems may be encountered. This section describes some common problem solving tips;

"IR Disconnection" error during treatments.

A beep followed by an "IR Disconnection" error on the display indicates a problem with a treatment surface area. Try adjusting how you are holding Dermaray UV lamp and ensure it is held flat against the treatment area. Also try adjusting how you move Dermaray UV lamp by experimenting with a faster or slower movement, circular movements can also work for some situations.

If Dermaray UV lamp is used near strong fluorescent light or near a strong natural light source, then the IR Detection could be more sensitive than usual. Try moving to another room or adjusting your position away from another strong light source.

The IR Sensitivity can be adjusted in the System Tools menu, in extreme cases it can also be disabled. Disabling IR Detection is NOT recommended.

Dermaray UV lamp turns on, but won't start.

If Dermaray UV lamp shows a Yellow power led, but has no display on the display, please firstly ensure that battery is fully charged. If the problem persists follow the instructions for a Hardware Reset.

Specifications

ITEM	DESCRIPTION
Product name:	Dermaray UV
Size of device:	H x W x D
Weight of device: Actual	Approx 1.0 Kg
Shipping size:	36.5 x 15.5 x 8cm
Shipping weight: Packaged	Approx 1.5 kg
Operating temperature:	5-45c
Internal cut out temperature:	~ 65c
Battery type:	4 x AA 2100mAh NiMH
Battery operating capacity:	~45 min continual use
Exposures per battery charge:	~15 depending on duration
Power supply:	100-240v 50-60Hz
Power input:	8VDC – 3.0A
Power consumption:	11 W
Microprocessor:	PLC2138 (32bit, 60MHz)
Onboard memory:	512kb FLASH
PC Interface:	USB*
Bulb type:	Custom Philips TL01 type*
Patents:	Registered & pending

***WARNING:** Use only genuine Dermaray UV lamp USB cable and genuine Dermaray UV lamp replacement parts. Using non-genuine parts may cause damage to the device and void your warranty.

Menu Structure Flow Chart

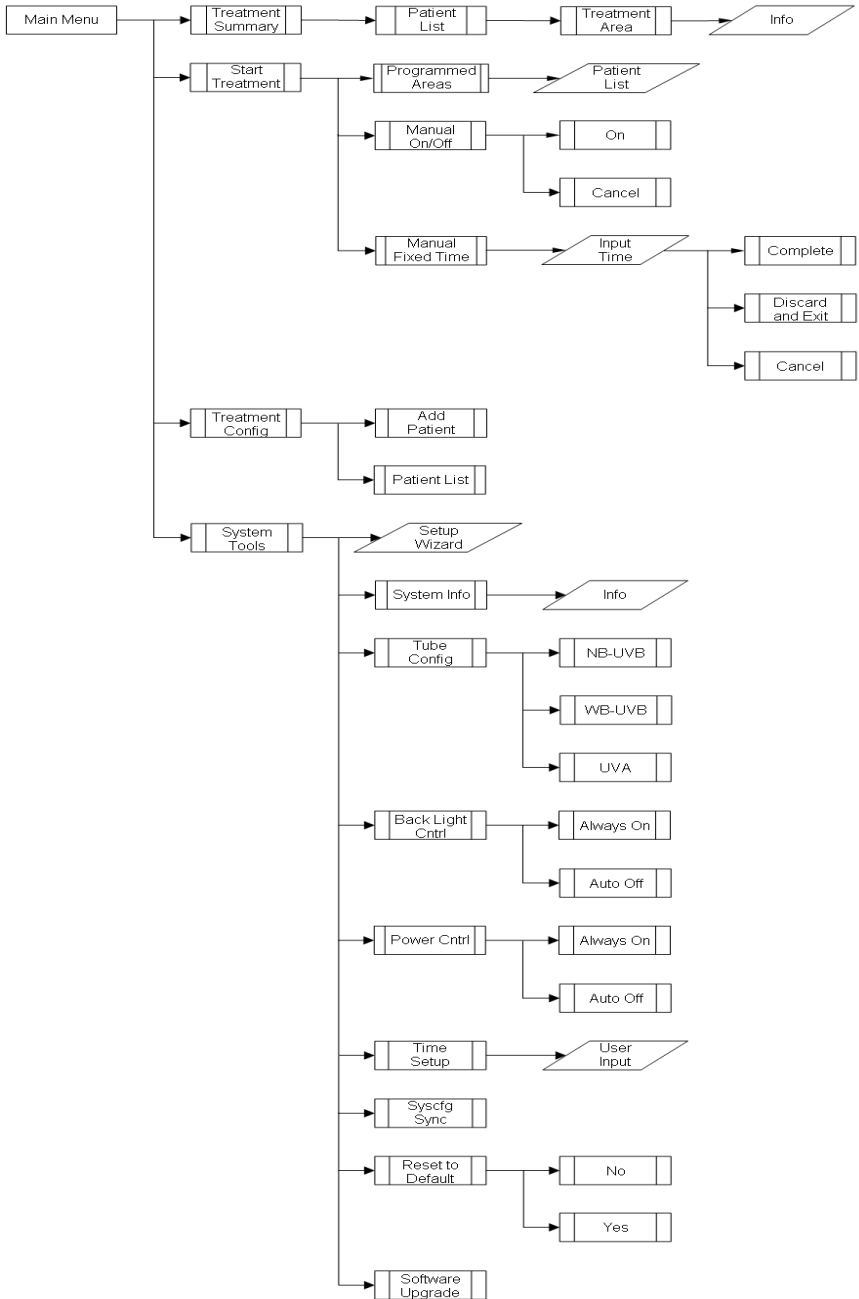

Warranty Information – Dermaray UV lamp

Your Dermaray UV lamp is covered under the manufacturer's warranty against all defects in materials and workmanship for a period of Two Years (2 years) from the date of the original purchase, subject to the following terms and conditions.

This warranty is not limited to the original owner and is fully transferrable. This warranty does not apply if the serial number or housing of the product has been removed, or if the product has been subject to physical abuse, improper installation, or modification. This warranty is only valid when a bill of original sale and a completed warranty registration form is received by Dermaray. Change of ownership must be notified in writing to Dermaray for warranty transfer purposes.

For products purchased from an authorised distributor, please contact that distributor to arrange warranty service, repair or replacement. Products not purchased directly may be returned, but return shipping must be paid by the customer and a service fee may apply. To obtain warranty service from products purchased directly from Dermaray.com, the product must be returned, insured and shipping prepaid to Total Control Pty. Ltd. at the address following, in its original packaging or suitable equivalent, along with a written description of the problem and the customer's full name, return address, contact telephone numbers and email.

Return Authorisation Numbers (RAN#) must be obtained and marked clearly on the outside of the package being returned. A service fee applies for items returned with no fault found. Items returned without your RAN # may not be accepted.

Total Control Pty. Ltd. disclaims all other warranties, expressed or implied, including warranties of merchantability and fitness for any particular purpose whatsoever and no other remedy shall be available, including without limitation, incidental or consequential damaged. In no event shall Total Control Pty. Ltd. liability exceed the purchase price of the product in question.

Total Control Pty. Ltd. wants you to be satisfied with its products. Should you have any difficulties with operation or performance with your Dermaray UV lamp, please contact us immediately.

Warranty Registration Form

NOTE: To register and activate your warranty, this form must be completed and returned to the manufacturer directly with a copy of your invoice or bill of sale. Change of ownership must be notified to Dermaray in writing. Warranty may also be submitted online www.dermaray.com/registration.htm

Customer Information;

Full name: _____

Address: _____

Town/City: _____

Zip Code: _____ Country: _____

Phone: _____

Mobile: _____

Email: _____

Why you chose this product: _____

Would you like to be informed of new products, updates and other important information by email? Yes No

Place of Purchase Information;

Date of purchase: _____ / _____ / _____

Supplier's name: _____

Supplier's address: _____

Supplier's phone: _____

Suppliers web page: _____

Purchase price: _____

This page is for your personal schedule of appointments and for general notes

Doctor / Specialist : _____
Treatment Type/Plan: _____

Year **Month** **Day** **Time**

Sun	Mon	Tue	Wed	Thu	Fri	Sat

Notes

Dermaray®

Meeting the Challenges



Total Control Pty. Ltd.
3/6 Barnett Court Morley
WA 6062 Australia
Web www.dermaray.com
All rights reserved.

Dermaray is a registered trademark of Total Control Pty. Ltd. Australia